

**TME-2200 Rakenteiden mekaniikka**

2. välikoe 24.5.2010 (uusinta)

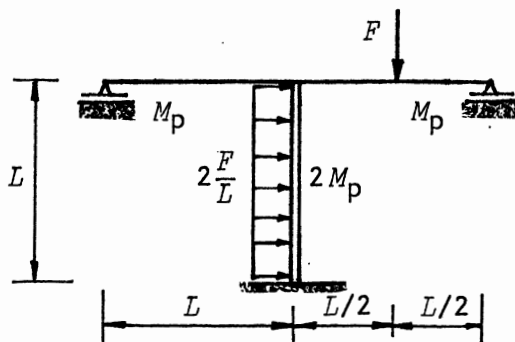
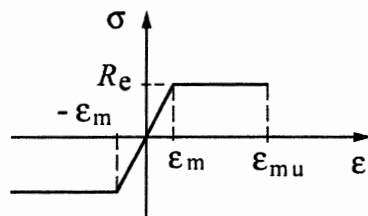
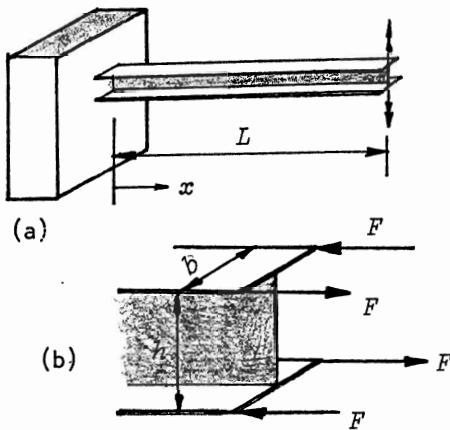
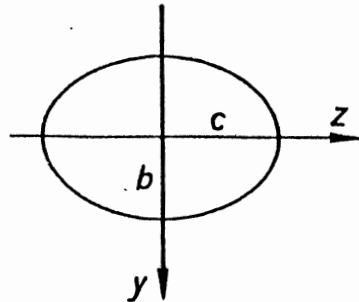

1. Määritä vääntösauvan, jonka poikkileikkaus on kuvan ellipsi, vääntöneliömomentti käyttämällä estimaattia

$$\tilde{f}(y,z) = \frac{c^2 - b^2}{c^2 + b^2} yz$$

$$I_z = \frac{1}{4} \pi b^3 c, \quad I_y = \frac{1}{4} \pi b c^3$$

2. Kuvan ulokepalkin poikkileikkauksen uuman korkeus on  $h$  ja laippojen leveys  $b$ . Määritä palkin bimomentin lauseke  $B(x)$  ja vapaan pään kiertymä. Palkin poikkileikkauksen jäykkyydet  $GI_v$  ja  $EI_\omega$  tunnetaan.

3. Kuvan palkin poikkileikkaus, joka on suorakulmio  $b \times h$ , murtuu, kun venymä vetopuolella saavuttaa arvon  $\epsilon_{mu}$ . Määritä poikkileikkauksen plastinen momentti  $M_p$ .

4. Määritä kuvan kehän rajakuormitus *kinemaattisella menetelmällä*. Käytä mekanismia, jossa pystypalkilla on plastisia niveliä, joiden paikat ovat tuloksen tarkkuuden kannalta parhaimmat mahdolliset.

## 2305410 Palkkirakenteet

Kaavakokoelma/Tapio Salmi sl. 2003

$$f(x) = \langle x-a \rangle^n = \begin{cases} (x-a)^n, & x \geq a \\ 0, & x < a \end{cases}$$

$$\frac{d}{dx} \langle x-a \rangle^0 = \langle x-a \rangle_{-1} = \begin{cases} 0, & x < a \\ \infty, & x = a \\ 0, & x > a \end{cases}$$

$$\frac{dR}{dx} = \tau_{sx} t = -\frac{Q_y S_z}{I_z} - \frac{Q_z S_y}{I_y} = \tau_{xs} t = q$$

$$A^\lambda = \iint_A dA^\lambda = \iint_A \lambda(y,z) dA$$

$$S_y^\lambda = \iint_A z dA^\lambda = \iint_A z \lambda(y,z) dA$$

$$I_z^E = \iint_A E(y,z) y^2 dA$$

$$I_{yz}^E = \iint_A E(y,z) yz dA$$

$$\sigma_x(A) = \frac{E_A N}{A^E} + \frac{E_A M_t \zeta}{I_\zeta^E} \eta_A + \frac{E_A M_t \eta}{I_\eta^E} \zeta_A$$

$$[L_\sigma] \{ \sigma \} + \{ \underline{f} \} = \{ 0 \}$$

$$[G] \{ \sigma \} = \{ \underline{p} \}$$

$$\{ u \} = \{ \underline{u} \}$$

$$W = \int_0^u F(\bar{u}) d\bar{u}$$

$$\delta W_u = \iint_{S_\sigma} \{ \underline{p} \}^T \{ \delta u \} dS_\sigma + \iiint_V \{ \underline{f} \}^T \{ \delta u \} dV$$

$$\delta W_s = -\iiint_V \{ \sigma \}^T \{ \delta \epsilon \} dV$$

$$\delta W_u + \delta W_s = 0$$

$$\delta W_u = \delta W_\sigma$$

$$\delta W_\sigma = \iiint_V \{ \sigma \}^T \{ \delta \epsilon \} dV = -\delta W_s$$

$$\delta U = \iiint_V \{ \sigma \}^T \{ \delta \epsilon \} dV$$

$$\delta U_0 = \{ \sigma \}^T \{ \delta \epsilon \}$$

$$\delta W_u = \delta U$$

$$\delta W_u = -\delta V$$

$$\{ \sigma \} = [E] \{ \epsilon \}$$

$$U_0 = \frac{1}{2} \{ \sigma \}^T \{ \epsilon \} = \frac{1}{2} \{ \epsilon \}^T [E] \{ \epsilon \}$$

$$\pi = U + V$$

$$\delta U_0 = \{ \epsilon \}^T [E] \{ \delta \epsilon \}$$

$$\delta \pi = 0$$

$$\delta^2 \pi \geq 0$$

$$\frac{\partial U}{\partial u_i} = F_i$$

$$\sigma_{ij} = \frac{\partial U_0}{\partial \epsilon_{ij}}$$

$$U = \frac{1}{2} \int_0^L (EA(u,x)^2 + EI(v,xx)^2 + GA\gamma^2 + GI_v \Theta^2) dx$$

van .

$$\int_{-\infty}^x \langle x-a \rangle_{-1} dx = \langle x-a \rangle^0$$

$$EI(x) v''(x) = -M_t(x)$$

$$\sigma_x = \frac{M_t}{I_z} y$$

$$\tau_{zx} = \tau_{xz} = \frac{\zeta}{z} \tau_{yx} \frac{dz}{dy}$$

$$y_0^\lambda = S_z^\lambda / A^\lambda \quad z_0^\lambda = S_y^\lambda / A^\lambda$$

$$S_z^\lambda = \iint_A y dA^\lambda = \iint_A y \lambda(y,z) dA$$

$$I_y^E = \iint_A E(y,z) z^2 dA$$

$$I_z = I_\zeta + A y_0^2$$

$$\epsilon_x = \frac{N}{A^E}$$

$$\tan \beta = \frac{I_\zeta^E}{I_\eta^E} \tan \alpha$$

$$\delta W = F \delta u$$

$$\begin{aligned} p_x &= \sigma_x l + \tau_{xy} m + \tau_{xz} n & \sigma_{x,x} + \tau_{xy,y} + \tau_{xz,z} + \underline{f_x} &= 0 \\ p_y &= \tau_{xy} l + \sigma_y m + \tau_{yz} n & \tau_{xy,x} + \sigma_{y,y} + \tau_{yz,z} + \underline{f_y} &= 0 \\ p_z &= \tau_{xz} l + \tau_{yz} m + \sigma_z n & \tau_{xz,x} + \tau_{yz,y} + \sigma_{z,z} + \underline{f_z} &= 0 \end{aligned}$$

$$\begin{aligned} \epsilon_x &= u_{,x} & \epsilon_y &= v_{,y} & \epsilon_z &= w_{,z} \\ \gamma_{xy} &= u_{,y} + v_{,x} & \gamma_{yz} &= v_{,z} + w_{,y} & \gamma_{xz} &= u_{,z} + w_{,x} \end{aligned} \quad \delta W^* = u \delta F$$

$$\delta W^* = \{u\}^T \{\delta F\} \quad \delta W_u^* = \iint_S \{u\}^T \{\delta p\} dS + \iiint_V \{u\}^T \{\delta f\} dV \quad \delta W_u^* + \delta W_s^* = 0$$

$$\delta W_s^* = -\iiint_V \{\epsilon\}^T \{\delta \sigma\} dV \quad \delta W_\epsilon^* = \iiint_V \{\epsilon\}^T \{\delta \sigma\} dV \quad \delta W_u^* = \delta W_\epsilon^*$$

$$\delta W_\epsilon^* = \sum_{v=1}^n \int_{L_v} (\epsilon_0 \delta N + \kappa_y \delta M_{ty} + \kappa_z \delta M_{tz} + \gamma_y \delta Q_y + \gamma_z \delta Q_z + \Theta \delta T) dx$$

$$u_i \cdot 1 = \iiint_V \{\epsilon\}^T \{\bar{\sigma}\} dV$$

$$u_i \cdot 1 = \sum_{v=1}^n \int_{L_v} (\epsilon_0 \bar{N} + \kappa_y \bar{M}_{ty} + \kappa_z \bar{M}_{tz} + \gamma_{xy} \bar{Q}_y + \gamma_{xz} \bar{Q}_z + \Theta \bar{T}) dx$$

$$u_i \cdot 1 = \sum_{v=1}^n \int_{L_v} \left( \frac{N \bar{N}}{EA} + \frac{M_{ty} \bar{M}_{ty}}{EI_y} + \frac{M_{tz} \bar{M}_{tz}}{EI_z} + \zeta_y \frac{Q_y \bar{Q}_y}{GA} + \zeta_z \frac{Q_z \bar{Q}_z}{GA} + \frac{T \bar{T}}{GI_v} \right) dx$$

$$u_i \cdot 1 = \sum_{v=1}^n \int_{L_v} \frac{N \bar{N}}{EA} dx \quad u_i \cdot 1 = \sum_{v=1}^n \int_{L_v} \frac{M_{tz} \bar{M}_{tz}}{EI_z} dx \quad [a] \{X\} + \{u_0\} = \{u\}$$

$$u_{0i} = \sum_{v=1}^n \int_{L_v} \frac{M_{t0} \bar{M}_{ti}}{EI} dx \quad a_{ij} = \sum_{v=1}^n \int_{L_v} \frac{\bar{M}_{ti} \bar{M}_{tj}}{EI} dx \quad u = \sum_{v=1}^n \int_{L_v} \frac{M_t \bar{M}_{tu}}{EI} dx$$

$$M_t(x) = M_{t0}(x) + \sum_{i=1}^m X_i \bar{M}_{ti}(x) \quad v(x) = v_0(x) + \sum_{i=1}^m X_i \bar{v}_i(x)$$









$$\epsilon_{ij} = \frac{\partial U_0^*}{\partial \sigma_{ij}} \quad \delta U_0^* = \iiint_V \{\epsilon\}^T \{\delta \sigma\} dV \quad \delta W_u^* = -\delta V^* \quad \pi^* = U^* + V^*$$

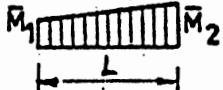
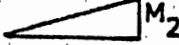

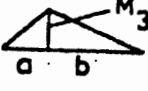
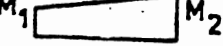
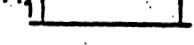
$$\delta \pi^* = 0 \quad u_i = \frac{\partial U^*}{\partial F_i} \quad \{F\}^T \{u^P\} = \{P\}^T \{u^F\}$$

$$U^* = \frac{1}{2} \int_L \left( \frac{N^2}{EA} + \frac{M_{ty}^2}{EI_y} + \frac{M_{tz}^2}{EI_z} + \zeta_y \frac{Q_y^2}{GA} + \zeta_z \frac{Q_z^2}{GA} + \frac{T^2}{GI_v} \right) dx$$

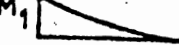
Taulukko 1. Mohrin työintegraaleja.

Taulukossa on otsikon viivoitetun kolmio- tai trapetsifunktion  $\bar{M}$  ja kullakin rivillä esitetyn kolmio- trapetsi- tai paraabelifunktion  $M$  integraali. Kunkin paraabelin huippu on joko integroimisalueen  $L$  reunassa tai sen keskellä.

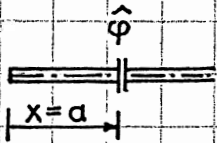
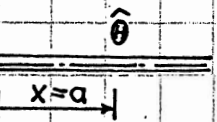
		$\int_0^L \bar{M} M dx$			$\int_0^L \bar{M} M dx$
1		$\frac{1}{3} L \bar{M}_2 M_2$		1	$\frac{1}{2} L (\bar{M}_1 + \bar{M}_2) M_1$
2		$\frac{1}{6} L \bar{M}_2 M_1$		2	$\frac{1}{6} L [\bar{M}_2 (2M_1 + M_2) + \bar{M}_1 (M_1 + 2M_2)]$
3		$\frac{1}{6} L \bar{M}_2 M_3 \left(1 + \frac{a}{L}\right)$		3	Kun $M = \bar{M}$ , $\frac{1}{3} L (M_1^2 + M_1 M_2 + M_2^2)$
4		$\frac{1}{6} L \bar{M}_2 (M_1 + 2M_2)$		4	$\frac{1}{12} L (3\bar{M}_1 + 5\bar{M}_2) M_2$
5		$\frac{1}{2} L \bar{M}_2 M_1$		5	$\frac{1}{12} L (\bar{M}_1 + 3\bar{M}_2) M_2$
6		$\frac{5}{12} L \bar{M}_2 M_2$		6	$\frac{1}{3} L (\bar{M}_1 + \bar{M}_2) M_3$
7		$\frac{1}{4} L \bar{M}_2 M_1$		7	$\frac{1}{6} L \left[ \bar{M}_1 \left(1 + \frac{b}{L}\right) + \bar{M}_2 \left(1 + \frac{a}{L}\right) \right] M_3$
8		$\frac{1}{4} L \bar{M}_2 M_2$			
9		$\frac{1}{12} L \bar{M}_2 M_1$			
10		$\frac{1}{3} L \bar{M}_2 M_1$			

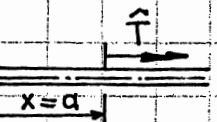
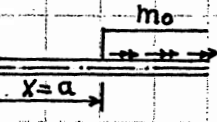
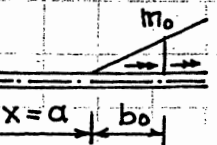
Kuormitus Loading	$\hat{\varphi}_i(x)$ ; $\hat{\varphi}(x) = \sum_i \hat{\varphi}_i(x)$
	$\hat{\varphi} < 1 >_a$
	$\frac{\hat{\theta}}{\lambda} < \sinh \lambda(x-a) >_a$
	$\frac{-\hat{B}}{GI_v} < 1 - \cosh \lambda(x-a) >_a$
	$\frac{-\hat{T}}{GI_v \lambda} < \lambda(x-a) - \sinh \lambda(x-a) >_a$
	$\frac{m_0}{GI_v \lambda^2} < \cosh \lambda(x-a) - 1 - \frac{[\lambda(x-a)]^2}{2} >_a$
	$\frac{m_0/b_0}{GI_v \lambda^3} < \sinh \lambda(x-a) - \lambda(x-a) - \frac{[\lambda(x-a)]^3}{6} >_a$

$$\Theta = \varphi_{,x} \quad , \quad \Theta = T / GI_y \quad , \quad \nabla^2(\cdot) = (\cdot)_{,xx} + (\cdot)_{,yy}$$

$$u = \Theta f(y, z) \quad , \quad v = -\Theta xz \quad , \quad w = \Theta xy$$

$$\begin{cases} \nabla^2 f(y, z) = 0 & , \quad (y, z) \in A \\ f_{,n} = zn_y - yn_z & , \quad (y, z) \in \partial A \end{cases}$$

$$I_y = I_p + \iint_A (y f_{,z} - z f_{,y}) dA \quad , \quad I_p = \iint_A r^2 dA$$

$$\tau_{xy} = \phi_{,z} \quad , \quad \tau_{xz} = -\phi_{,y} \quad , \quad \nabla^2 \phi = -2 G\Theta$$

$$T = 2 \iint_{\partial A} (-yn_y - zn_z) \phi dA + 2 \iint_A \phi dA \quad , \quad T = 2 \iint_A \phi dA$$

$$T = 2 \iint_A \phi dA + 2 \sum_{i=1}^n \phi_i A_i \quad , \quad T = 2 \iint_{A^*} \phi dA$$

$$\phi = \Phi / G\Theta \quad , \quad I_y = 2 \iint_{A^*} \Phi dA \quad , \quad \nabla^2 \Phi = -2$$

$$W_y = \frac{I_y}{\max |\nabla \phi|} \quad , \quad \tau_x = G\Theta |\nabla \phi|$$

$$\Psi = \iint_A [(f_{,y} - z)^2 + (f_{,z} + y)^2] dA \quad , \quad I_y = \Psi \quad , \quad I_y \leq \bar{\Psi}(\bar{f}(y, z))$$

$$\Psi^* = \iint_A (\phi_{,y}^2 + \phi_{,z}^2 - 4\phi) dA - 4 \sum_{i=1}^n \phi_i A_i \quad , \quad I_y = -\Psi^* \quad , \quad I_y \geq -\bar{\Psi}^*(\bar{\phi}(y, z))$$

$$-\bar{\Psi}^* \leq I_y \leq \bar{\Psi} \quad , \quad \oint_{\partial A} \bar{\tau}_x \cdot \bar{ds} = G\Theta \cdot 2A$$

$$I_y = 4A^2 / \oint_{\partial A} \frac{ds}{t} \quad , \quad \tau_x = T / 2At \quad , \quad W_y = 2A t_{\min}$$

$$K_{ki} = \oint \frac{ds}{t_{ki}} \quad , \quad K_{ki} = \frac{s_{ki}}{t_{ki}}$$

$$\sum_{\substack{i=0 \\ i \neq k}} K_{ki} (\phi_k - \phi_i) = 2A_k \quad , \quad k = 1, \dots, n$$

$$I_y = 2 \iint_A \phi dA \approx 2 (\phi_1 A_1 + \phi_2 A_2 + \dots + \phi_n A_n) \quad , \quad W_y = \frac{I_y}{\max \left| \frac{\phi_k - \phi_i}{t_{ki}} \right|}$$

$$\omega^1 - \omega^2 = (z_N^1 - z_N^2)(y - y_B) - (y_N^1 - y_N^2)(z - z_B); \quad A_\omega = A = \iint_A \omega^0 dA = \oint t ds$$

$$S_\omega = \iint_A \omega dA = \oint \omega t ds, \quad I_\omega = \iint_A \omega^2 dA = \oint \omega^2 t ds$$

$$I_{y\omega} = \iint_A y \omega dA = \oint y \omega t ds, \quad I_{z\omega} = \iint_A z \omega dA = \oint z \omega t ds$$

$$z_N = z_N^a - I_{y\omega^a} / I_z, \quad y_N = y_N^a + I_{z\omega^a} / I_y$$

$$\omega_0 = \iint_A \omega^B dA / A, \quad \omega = \omega^B + \omega_0$$

$$u = -\theta \omega, \quad \sigma_\omega = -E \varphi_{,xx} \omega, \quad \tau_\omega = \frac{E \varphi_{,xxx} S_\omega(s)}{t(s)}$$

$$T = T_{SV} + T_\omega, \quad T_{SV} = GI_V \theta = GI_V \varphi_{,x}$$

$$I_V \approx \frac{1}{3} \oint t^3 ds = \frac{1}{3} \sum_i t_i^3 s_i, \quad G = E / 2(1+\nu)$$

$$T_\omega = -EI_\omega \varphi_{,xxx}, \quad \lambda^2 = GI_V / EI_\omega$$

$$\varphi_{,xxxx} - \lambda^2 \varphi_{,xx} = m / EI_\omega, \quad T_{,x} = -m(x)$$

$$\varphi_{,xxx} - \lambda^2 \varphi_{,x} = -T / EI_\omega, \quad \theta_{,xx} - \lambda^2 \theta = -T / EI_\omega$$

$$N = EA u_{,x}, \quad M_{ty} = -EI_y \omega_{,xx}, \quad M_{tz} = -EI_z v_{,xx}$$

$$B = \iint_A \omega \sigma_x dA = -EI_\omega \varphi_{,xx}, \quad \sigma_\omega = \frac{B}{I_\omega} \omega$$

$$\sigma = \frac{N}{A} + \frac{M_{tz}}{I_z} y + \frac{M_{ty}}{I_y} z + \frac{B}{I_\omega} \omega$$

$$\tau = -\frac{Q_y S_y(s)}{I_y t(s)} - \frac{Q_z S_z(s)}{I_z t(s)} - \frac{T_\omega S_\omega(s)}{I_\omega t(s)}$$

$$\varphi(x) = \varphi_0 + \frac{\theta_0}{\lambda} \sinh \lambda x - \frac{B_0}{GI_V} (\cosh \lambda x - 1) - \frac{T_0}{GI_V \lambda} (\sinh \lambda x - \lambda x) + \hat{\varphi}(x)$$

$$\langle f(x) \rangle_a = \begin{cases} 0, & \text{kun } x < a \\ f(x), & \text{kun } x > a \end{cases}$$

$$\text{EULER II: } P_n = \pi^2 EI / L^2, \quad k^2 = P / EI$$

$$v_{,xxxx} + k^2 v_{,xx} = k^2 q / P$$